

# PROFESSIONAL STAGE & STUDIO EQUIPMENT



[www.fortlamps.ru](http://www.fortlamps.ru) +7495 749 66 09 [info@fortlamps.ru](mailto:info@fortlamps.ru)

**KUPO**<sup>®</sup>



# PROFESSIONAL STAGE & STUDIO EQUIPMENT PROVIDER

## WHO WE ARE

KUPO is one of the leading hardware solutions providers in the entertainment industry. We design, manufacture and distribute sophisticated products, including lighting and camera support, power connection, gear protection case, shopfitting display, lifting equipment and control systems.

For more than four decades, KUPO has established a well-recognized reputation for quality and innovation. Our customers are around the globe who work behind the scenes as the photographer, video and cine image-provider, theatre, concert hall, touring crews, and lighting designers. KUPO has forged its own path to the world by crafting innovative tools with unparalleled quality, sought after and shaped by industry professionals worldwide. To meet these professionals' needs, we offer numerous patent products including quick release and locking C-stand, multi direction easy storage Click Stand, auto self-locking Wind-up stand, lever lock and release device for Kupole, anti-slip rosettes friction disc of Max Arms, quick action Telescopic Hanger and the list goes on. All KUPO products have been painstakingly machined so you know you can count on their incredible strength and durability in harsh production environments. They are so durable, in fact, that they create a history of their own through their many years of service. Moreover its reliability is credited for certificates such as TUV-GS, CE, UL and CUL for several electrical products and the most popular Wind-up stand, Clamps, Couplers and Safety Wire.

## OUR DRIVING FORCE

Our commitment to improvement is constant, we dedicate ourselves in creating Humanism, Quality, Invention and Safety to our people (both employee and customer), and our environment also to the booming content creation market. To those who work behind the scenes and stages, we consider you, the content creator, a partner, integral to our innovative process. We greatly value your experience and listen carefully to both your needs and desires, which inspires us to create better tools to empower your professionals to capture and share exceptional content. Enjoy your ride with us, when it comes to helping you achieve your vision dream with KUPO equipment,

**WE LIKE TO SAY AT KUPO:  
*NEVER LET GO***



**YOUTUBE  
KUPO FACTORY  
INTRODUCTION VIDEO**



# GEAR PROTECTION INDEX

Luminaire Waterproof Dome .....	262 - 264
Luminaire Rain Cover .....	265
CROXS Case .....	266 - 269
CROXS Case for GoPro Hero Kits ...	270
CROXS Combo Case .....	271
CROXS Case for Stand Top .....	272
CROXS Case for Memory Card Case	273
CROXS Case Quick Guide .....	274 - 275

## Content

The always ready-to-go CROXS case is designed for diverse applications where advanced protection to the equipment is an absolute must. CROXS hard cases are made of superior plastic material, making it sturdy and robust. Each case comes with an intelligent air pressure regulator, that allows for water-proofing but still regulates internal pressure within the container. A few select size models of the CROXS cases meet FAA and can be carry-on luggage on flights. Explore every possibility with the CROXS case across all terrain.

Come and join us on [www.stage.com.tw](http://www.stage.com.tw)





The luminaire waterproof dome is designed to render protection to lighting fixture for outdoor application. It has a transparent globe that keep the luminaire away from moisture and humidity yet make a great amount of light passing through, eliminating light output loss. Steel base coated with anti-rust treatment together with stainless steel hardware makes this dome the maximum durability. Base is grey finish, other color upon request.

### Features

1. Soft-yet-hard globe always stays in shape, free from deformation in strong windy condition.
2. Vent tubes at two side can be formed in any direction to prevent water ingress.
3. Dome can be placed upright, fastened in horizontal side mounting, or rigged at upside down position.
4. Five selections of dome are available for the moving light with all kinds of dimensions; feasible for rain proof or any outdoor applications.

### General Technical Information

- Working Voltage: AC/100-240V
- Working Environment: -20 ~ 45 Celsius degree
- Protection Degree: IP54
- Globe Material: Made by premium grade transparent engineering plastic with high light transmittance, anti-ultraviolet radiation; free from getting yellow, and not easily break up.
- Light Transmittance: over 89%, similar to normal glass
- Base Material: Cold roll steel with thick anti-rust coating, and stainless steel hardware.
- Control: DMX-512
- Signal and power connections: two waterproof 3-pin XRL, and two waterproof power cable.
- In-globe power & signal outlet (for connecting moving light): universal AC socket, 3-pin XLR socket (please specify on the order if other kind of outlet is requested).

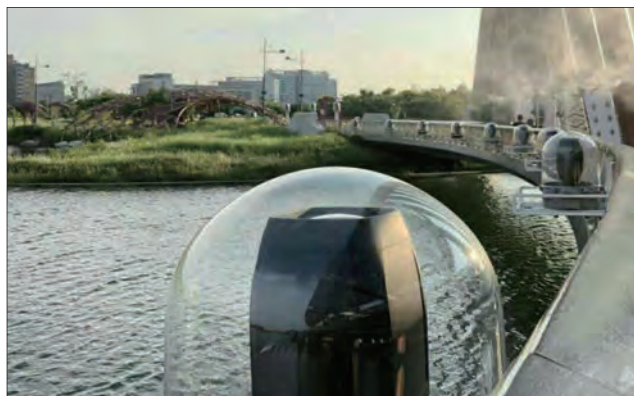

**YOUTUBE**  
**KUPO LUMINAIRE**  
**WATERPROOF DOME**

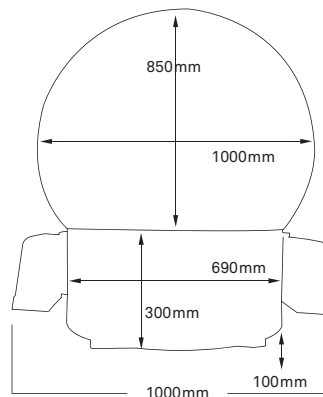

### KWP-1500 Luminaire Waterproof Dome

Overall Height: 1250mm  
 Globe Diameter: 1000mm  
 Net Weight: 30kg

-  
 Suitable for 1200W/1500W moving head light, or the light with similar dimensions.  
 Please leave the distance at least 80mm between the top of moving head and globe.

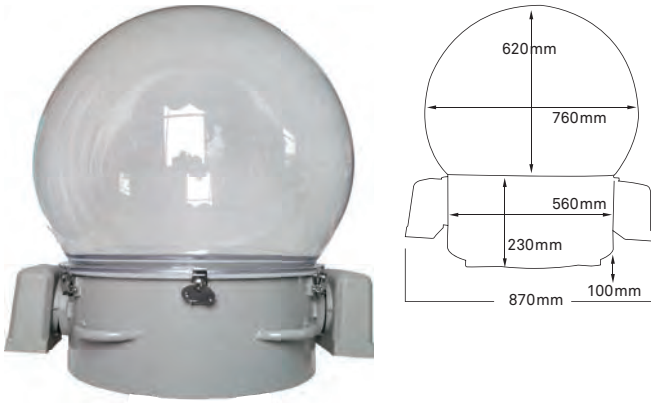

**KWP-1000** Luminaire Waterproof Dome

Overall Height: 950mm  
 Globe Diameter: 760mm  
 Net Weight: 22kg

- Suitable for 470W/1000W moving head light, or the light with similar dimensions. Please leave the distance at least 80mm between the top of moving head and globe.

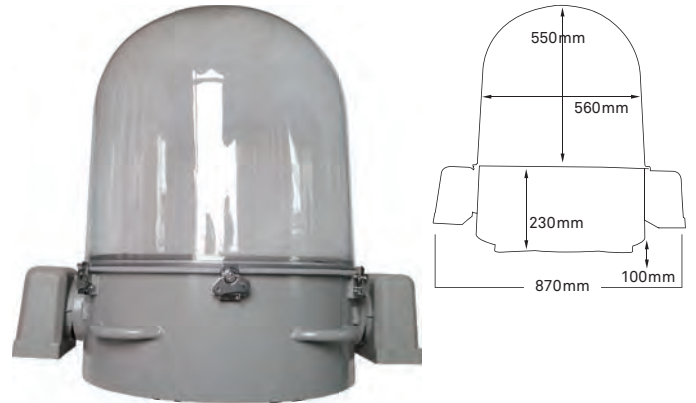

**KWP-900** Luminaire Waterproof Dome

Overall Height: 880mm  
 Globe Diameter: 560mm  
 Net Weight: 21kg

- Suitable for 440W/470W beam light, or the lights with similar dimensions. Please leave the distance at least 80mm between the top of moving head and globe.

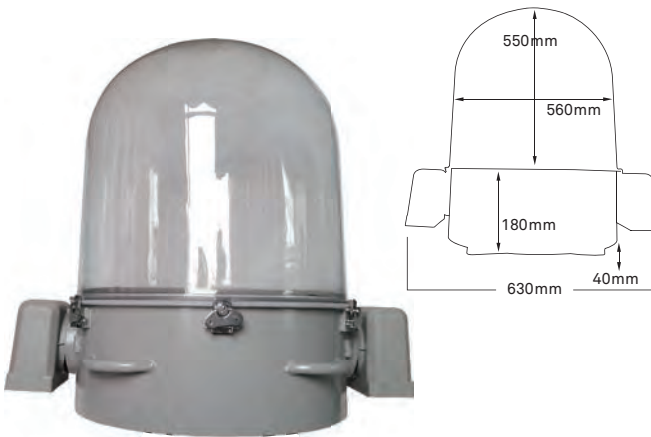

**KWP-800** Luminaire Waterproof Dome

Overall Height: 770mm  
 Globe Diameter: 560mm  
 Net Weight: 17kg

- Suitable for 280W/380W beam light, or the lights with similar dimensions. Please leave the distance at least 80mm between the top of moving head and globe.

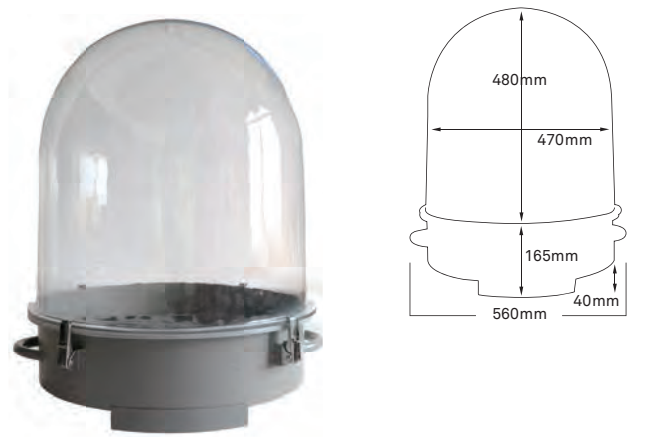

**KWP-300** Luminaire Waterproof Dome

Overall Height: 685mm  
 Globe Diameter: 470mm  
 Net Weight: 16kg

- Suitable for 200W/230W moving head light, or the light with similar dimensions. Please leave the distance at least 80mm between the top of moving head and globe.







Six stainless buckles mounted on the base are provided to fix the transparent dome firmly.



Two fan-equipped ventilation holes per each base, for fresh air intake to cool down the working temperature inside. Ventilation hole is covered with duct protector to protect fan from damage.



Silicone ring is fully covered up the edge of base, offering seal contact between transparent dome and metal base.



Power and DMX signal cable are terminated with waterproof connectors. Universal power socket and 3-pin XLR receptacle are equipped inside the base for connecting the moving light.



Two brackets with 1/4 turn knobs are provided for fastening the moving light. The groove makes the bracket freely adjustable to comply with the diverse the luminaire design.

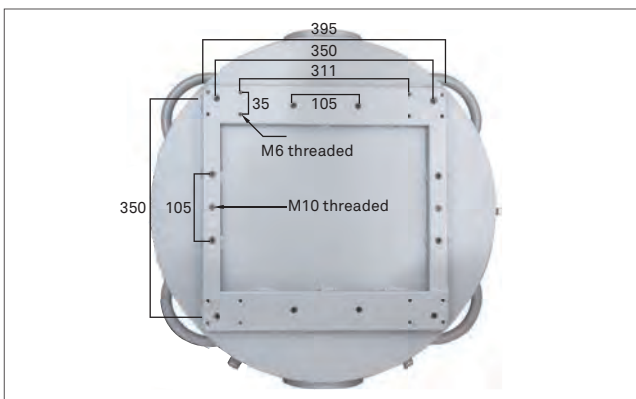

M6 and M10 thread holes are available for the add-on caster to attach, making the waterproof dome with greatest mobility.



An overlook of Luminaire Waterproof Dome and its accessories.

These covers are designed to provide rain protection to the luminaire at downward projection position. Open-at-bottom design is excellent for heat ventilation. Upper layer is made of black nylon fabric with inner side PVC coated for water resistance. Lower layer is made of transparent PVC fabric for rain repellence and great see-thru visibility. Five selections available for diverse lighting fixtures.



**Features**

1. Double stitches for better strength.
2. Steel wire inside the rim of top and/or bottom is working as a ballast, keeping the cover barrel in shape.
3. Hook and loop fastener for easy adjustment.
4. Tether rope (subject to model D & E) gives the flexibility to add on or remove the transparent barrel.
5. Cable side entry with lid cover formed slightly downward to prevent water ingress.

**Specification**

- Upper layer material: black nylon fabric with PVC coated.
- Lower layer material : transparent PVC.
- Working Environment: max. 60 Celsius degree.



**YOUTUBE  
LUMINAIRE  
RAIN COVER**

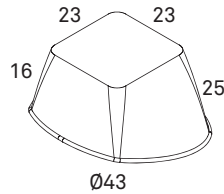

**KWP-A** Luminaire Rain Cover

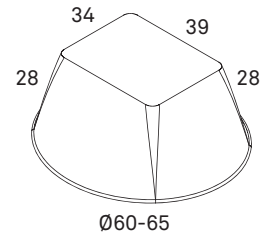

**KWP-B** Luminaire Rain Cover

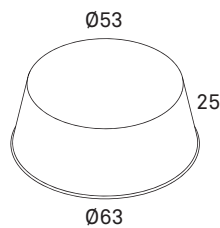

**KWP-C** Luminaire Rain Cover

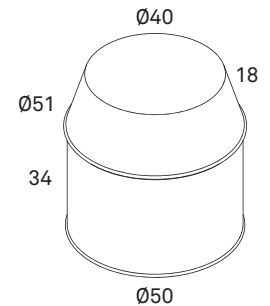

**KWP-D** Luminaire Rain Cover

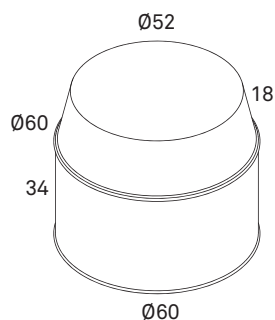

**KWP-E** Luminaire Rain Cover





# EXTREME GEAR ON THE GO

CROXS, the hard cases series, featuring excellent water-proof and maximum durability, offers the greatest protection to your precious items. Travel with CROXS over rigorous transportation condition. Travel with peace of mind.





CROXS is a hard case series for boundless exploration, designed and manufactured for giving greatest protection to equipment over heavy transportation or rigorous weather condition. CROXS is engineered in high standard for catering to diverse demands from individuals, industrial users, government or even military department. Born to cross the boundary where extreme limit is invisible.



**YOUTUBE**  
CROXS CASE



**YOUTUBE**  
INTRODUCING  
CROXS CASE

### CX5219 CROXS Case



Patent locking latch ensures two shells firm lock and prevents unexpected pop-up.



Rubber O-ring at the rim of upper shell offers excellent water-tightness.

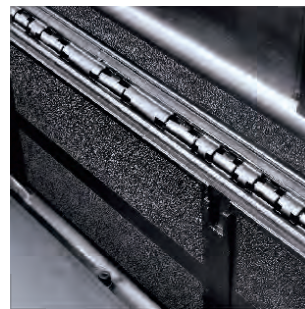

Enhanced hinge engaged shell and box without interval gap for utmost durability.



Traveling noise is greatly eliminated by rubber-encapsulated nylon caster, making it quite silent on the go (for models with casters only).



Reinforcement at corner for max. toughness and durability.



Extraordinary air pressure regulator for automatically adjusting the inner box pressure in accordance with the ambient air pressure but also keep the box free from water invasion. (auto air regulator applied for selected models only).



Egg-crate and pick-and-pluck foam for making custom-fit protection in line with any shape of equipment.



· Wide variety selections for diverse needs.

Made of injection-molded PP compound for the advantage of anti-rust, corrosion free, dust-proof and impact resistant.



Enhanced haulage handle, head of integrated shaping plastic, endures higher bending force.





Wide variety selections for diverse needs.



Meet FAA regulation for carry-on luggage on flight (selected models only).

Made of injection-molded PP compound for the advantage of anti-rust, corrosion free, dust-proof and impact resistant.

**OPTIONAL ACCESSORIES**



**Specifications:**

Material	Lock housing: Zinc alloy / Dial: Zinc alloy Steel cable
Finishing	Black color coated
Lock Body:	(L)37 x (W)12 x (H)70 mm
Cable:	2mm (Dia.) W/ transparent PVC sleeves

**CXLC01 TSA Lock for All CROXS Cases**

Made from robust Zinc alloy and with elegant black powder coat, this 3-dial combination TSA-friendly lock stands up to the wear and tear luggage handling. Flexible steel cable with transparent PVC sleeve and ergonomic-design bottom makes the use of the lock easier and efficiently. Keep your luggage with the lock that TSA screener won't cut. Compatible with all CROXS cases.



110 (L) x 55(W) x 15 (H) mm  
Weight: 56 g

**CXSG01 Lockdown 40 Gram Silica Gel for All CROXS Cases**

Silica gel is enclosed in a compact aluminum canister for putting in CROXS case to protect camera or computer equipments from moisture. Eco-friendly design that put it in oven at 120 degree Celsius for about 3 hours while the indicator window sees green, and you'll have a whole new Silica gel. Good for traveling to different locations where moisture is a concern.



**KAB-021 KUBO Seat Cushion (20X30cm) for Protective Hard Case CX5219**

The seat cushion constructed from 1000-denier textured nylon has a 2" pad, which provides comfortable seating when the cover is placed over a protective hard case box such as Kupo CROXS case CX5219 or Pelican 1519 in a vertical orientation. Features a wide opening with a durable drawstring closure makes it easy keep the seat cushion attached securely. The unique "Trolley sleeve" design also allows you to use haulage handle without taking off the seat cushion when it's required to move the case.



## PERSONALIZED NAMEPLATE

Some selections of CROXS case come with nameplate slot for personalized nameplate. Made of ABS with black on surface, your information on nameplate will be engraved with white color for straight recognition immediately. Nameplate helps to well organize your gear and facilitate the recovery while your case gets lost.

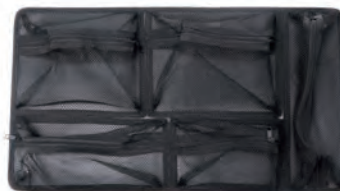

## CXFM01

Fix Mount is a must-have accessory turning a CROXS hard case to professional instrument case. While delicate instrument like controller would blend into CROXS case, this bracket is the way to do. Only few simple steps to provide great protection to instrument by attaching Fix Mount to the groove inside the CROXS case and fix instrument on it without too much effort. A set of 8pcs, and feasible for some selections of Crox case.

## CXLG01 Lid Organizer for CX5219 Case

The lid organizer has five mesh zippered pockets on the plastic plate which is easy to be attached to the lid of CROXS 5219 case with enclosed screws. The mesh compartments offer ample room to store tools, electronic and other convenient items. A wonderful addition to the case and keeps it organized.

Dimension: 27.98 (W) x 50.8(H) x 2.54(D) cm / Weight: 652 g

## PADDED DIVIDER

Padded divider set is alternative protection coming with 5 large and 6 small flexible dividers, turning the case in much well-organized way. Hook-and-loop fastener on dividers makes it easily manage the limited space.



## CXPD01

Padded divider set for CX5219  
L x W x H (cm): 52.1 x 29.1 x 19.2

## CXPD02

Padded divider set for CX7326  
L x W x H (cm): 73.6 x 45.7 x 26.9





## CROXS CASE SHOULDER STRAP HOLDER

Whenever you need a shoulder to carry on, the D-ring fix mount kit helps to achieve what you expect for your CROXS case. Just several steps and tools away, the selected hard cases will turn to be mobile with shoulder strap in easier way. Do it yourself, feel this great and fun feature of CROXS case, and travel hands-free!



Enlarge the hole with 5.2mm twist drill bit.



YOUTUBE  
CROXS CASE  
FT. SHOULDER  
STRAP HOLDER



### CXFM02 D-ring Fix Mount Kit

for CX3815 and CX4316 hard case

### CXST01 Shoulder strap

## CROXS CASE FOR GOPRO

CX3009GP2 is the latest model to CROXS series, aiming to provide greatest protection to GoPro camera gears. Designed for accommodating 2 sets of GoPro kits, this hard case features rugged plastic housing, water and dust proof, corrosion and impact resistance. Compound PP plastic and the rubber O ring makes this case excellent to resist most of harsh environment challenges, including temperature, moisture, certain acids and chemicals, offering the safe and secure space to settle your GoPro camera. \* GoPro is a registered trademark of GoPro Inc.



YOUTUBE  
CROXS CASE  
FOR GOPRO HERO KIT

#### Features

1. Made by rugged molded polypropylene.
2. Dust and Water Proof. (IP 67)
3. Weather Resistance.
4. Air Pressure Regulator.
5. Carry-on to fly.



### CX3009GP2 for GoPro HERO Kits

A neat and fantastic solution to organize GoPro cameras and accessories.



more accessories can be custom-fit in line with any shape of equipment.

Pick-and-pluck foam under the EVA foam.

Dual straps for lifting EVA foam easily.



## CROXS Combo Case

The lid is supplied with a large and a small removable pouch: the large for laptop up to MacBook 15" or folders or paperwork, and small for laptop peripherals or some hand tools. Those pouches are attached to the lid through hook-n-loop fastener and that's handy to organize them. The bottom is equipped with a nylon container for clothing, on which double zipper with a long handle helps to roll up fabric cover with no effort. Meet FAA requirement for carry-on luggage and ready to fly anytime.



### CX5219RTG CROXS 5219 Ready-To-Go Case

Dedicated for short term business traveler with less but important items to carry.



YOUTUBE  
CROXS COMBO CASE



### CX5219STG CROXS 5219 Studio-To-Go Case

For video professional and photographer on the travelling, the CROXS 5219 Studio-To-Go Case includes a set of padded divider and detachable laptop lid organizer. The laptop and accessory pouches on the lid accommodates up to MacBook 15" and its peripherals, making the most use of interior space and proceeding aviation security check with ease. The bottom comes with a set of padded divider for your own arrangement, giving fully protection to the video or camera equipments.

### CX5219GTG CROXS 5219 Gear-To-Go Case

Configuration is same as CROXS 5219 Studio-To-Go Case but with egg-crate foam on the lid instead, providing superior protection to all equipment carried in the case. Padded divider set enables you to organize the space to well fit the equipment you're going to put.



CROXS case-to-stand-top series allows you to mount hard case on the light stand or tripod with ease and convenience. These cases features a quick-release adapter, equipped underneath the case, can be detached in seconds makes it easy while traveling and storage. The quick release adapter comes with two 5/8" receivers offer you a choice of vertical or horizontal support placement using a traditional light stand, magic arm or pole. It's also compatible to tripod mounting thanks to the 1/4"-20 female threads, 3/8"-16 female threads and ARCA-Swiss style design on its underside.



**CST-2418** CROXS Case (CX2418) to Stand Top  
Interior size/ Lx Wx H (cm): 24.1x 18.8 x18.4

**CST-3815** CROXS Case (CX3815) to Stand Top  
Interior size/ Lx Wx H (cm): 38x 26.7 x15.7

**CST-5219** CROXS Case (CX5219) to Stand Top  
Interior size/ Lx Wx H (cm): 52.1x 29.1 x19.2

**Instruction to assemble the mounting adapter**



1. Insert adapter and align the key. 2. Twist to lock.



Case with no mounting adapter. Case with mounting adapter.



Application





**Exterior Size:** 12.0 x 8.3 x 2.0 (cm)  
**Interior Size:** 10.2 x 5.8 x 1.2 (cm)  
**Weight:** 0.16 kg

E8 slots for SD/SDHC/SDXC Cards  
 8 slots for Micro SD (TF) Cards



Removable wrist lanyard helps to carry this lightweight case with you easily



Made of ABS resin and double strengthened hinge mechanism; durable and tough



Snap locking lid keeps the case secured and stays firmly in case of unexpected drop-off



### CX1001 Memory Card Case



Pocket-size and compact. This protection and storage case is designed to accommodate up to 8 SD cards and 8 Micro SD card at once. Media storage memory cards will be duly protected by shock absorbing soft and elastic TPU slots. Your card will be kept safe from moisture while carried by this case. Comes with wrist lanyard for easy carry on the go.





### CX2418



Never has been such a hard case welcoming to photographer. This hard case has a compact profile as usual but it has roomy storage space to use. The depth of the compartment is quite as large as to accommodate shooting gears like camera and lens in one place. The puffy foams give the greatest protection to all of them and kept them secured from the damage over the transportation.



CROXS case			
Item	CX1001	CX1807	CX2109
Exterior Size / L x W x H (cm)	12.9 x 9.1 x 3.2	21.0 x 16.7 x 9.0	24.0 x 19.8 x 10.8
Interior Size / L x W x H (cm)	11.7 x 6.8 x 2.6	18.6 x 12.3 x 7.5	21.6 x 15.2 x 9.5
Net Weight (kgs)	0.11	0.6	0.75
Air Pressure Regulator	-	Manual	Manual
Carry-on to fly	☉	☉	☉
Haulage Handle	-	-	-
Wheel	-	-	-
Protective Foam	2 pre-cut EVA	2 pre-cut + 1 egg-crate	
Protection classification	ASTM / IP67		

CROXS case			
Item	CX2306	CX2413	CX2418
Exterior Size / L x W x H (cm)	24.0 x 17.5 x 7.7	30.0 x 25.0 x 14.5	30 x 24.8 x 21.2
Interior Size / L x W x H (cm)	23.5 x 14.5 x 6.2	24.0 x 19.0 x 13.0	24.1 x 18.8 x 18.4
Net Weight (kgs)	0.45	1.55	1.7
Air Pressure Regulator	Manual	Auto	Manual
Carry-on to fly	☉	☉	☉
Haulage Handle	-	-	-
Wheel	-	-	-
Protective Foam	1 pre-cut + 1 egg-crate	2 pre-cut + 1 egg-crate	
Protection classification	ASTM / IP67		

CROXS case			
Item	CX3009 / CX3009GP2	CX3815	CX4026
Exterior Size / L x W x H (cm)	33.2 x 28.0 x 12.0	42.0 x 33.0 x 16.6	42.8 x 28.3 x 27.5
Interior Size / L x W x H (cm)	30.0 x 22.0 x 10.1	38 x 26.7 x 15.7	40.5 x 23.1 x 26.0
Net Weight (kgs)	1.6	2.3	2.9
Air Pressure Regulator	Manual	Auto	Manual
Carry-on to fly	☉	☉	☉
Haulage Handle	-	-	-
Wheel	-	-	-
Protective Foam	3 pre-cut + 1 egg-crate		5 pre-cut + 1 Flat
Protection classification	ASTM / IP67		



<b>CROXS case</b>			
			
Item	CX4316	CX4818	CX5219 [RTG / STG / GTG]
Exterior Size / L x W x H (cm)	47.0 x 35.5 x 16.8	51.5 x 41.5 x 20.0	57.0 x 35.5 x 22.5
Interior Size / L x W x H (cm)	43.2 x 30.0 x 16.0	48.5 x 35.5 x 18.0	52.1 x 29.1 x 19.2
Net Weight (kgs)	2.6	4.3	5.4
Air Pressure Regulator	Auto	Manual	Auto
Carry-on to fly	☉	☉	☉
Haulage Handle	-	-	☉
Wheel	-	-	☉
Protective Foam		3 pre-cut + 1 egg-crate	
Protection classification		ASTM / IP67	

<b>CROXS case</b>		
		
Item	CX5632	CX7326
Exterior Size / L x W x H (cm)	63.2x 50.1 x 35.5	80.2 x 52.1 x 30.1
Interior Size / L x W x H (cm)	56.5x 43.8 x 32.3	73.6 x 45.7 x 26.9
Net Weight (kgs)	8.2	9.3
Air Pressure Regulator	Auto	Auto
Carry-on to fly	-	-
Haulage Handle	☉	☉
Wheel	☉	☉
Protective Foam	5 pre-cut + 1 egg-crate	3 pre-cut + 1 egg-crate
Protection classification		ASTM / IP67





[www.fortlamps.ru](http://www.fortlamps.ru) +7495 749 66 09 [info@fortlamps.ru](mailto:info@fortlamps.ru)

**KUPO CO., LTD (Headquarters)**  
**Tel : +886-2-2999-1906**  
**Fax: +886-2-2999-1955**  
**E-mail: [stage@kupo.com.tw](mailto:stage@kupo.com.tw)**

**6F, No 4, Lane 609, Sec.5, Chung Shin Rd., San Chung District,  
New Taipei City 24159, Taiwan**

**Kupo Shanghai (Branch office)**  
**Tel : +86-21-5677-9636**

**[www.stage.com.tw](http://www.stage.com.tw)**

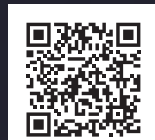

Product catalog download

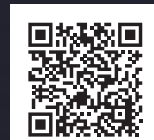

Product video channel

[ NOTE ] Whilst every effort has been made to ensure the accuracy of the information / material contained within this catalogue, Kupo does not accept any liability for errors or omissions. Specifications and technical data are provided for guidance purposes only. To improve products, we reserve the right to make any variation in design or construction to the equipment description without prior notice.

**[www.fortlamps.ru](http://www.fortlamps.ru)**