



CATALOG 2024



Why Choose **Auroras**?



Professional Support

The Auroras team offers the highest level of professional and technical support for pre and after sales service. Auroras team is well trained and experienced in high quality solar lighting and solar power systems. We are ready to provide you with competitive pricing and reliable quality. The Auroras team are passionate, committed, service driven communicators.



Innovative Products

Here at Auroras, we are constantly updating and improving our products to ensure we are in the best position to accelerate new technologies as they emerge, and to better serve our customers. We are motivated and inspired by how our valued customers use our highly engineered products to find creative solutions to complex problems, develop breakthrough scientific advancements, and stay ahead of the technological curve.

We maintain innovation as the focal point of our corporate mission and strive to provide state of the art products and solutions that help our customers pioneer into the future.



Territory Protection

Auroras is constantly seeking professional cooperation agreements with respected long-term clients; we believe an exclusive territory protection agreement is the best method of formalizing this valued cooperation. Auroras has a very transparent, although strict marketing policy to protect the rights and markets of the exclusive clients that hold territory protection agreements.

Auroras will only extend territory agreements to minimal clients within a territory. We base this selection on the size of the territory and a mutual understanding of quality solar products and professional marketing philosophy.



Committed to a better world with quality green energy.

By combining the best technology of lithium batteries, solar panel, led source, and advanced control systems, we offer the most reliable and high-efficiency solar lights for vast applications to reduce the pollution and cost of traditional resources.

Page of Catalog

01~10

Solar Lawn / Bollard Light

- * ARKO solar lawn light
- * ATOM solar bollard light
- * MUSE solar bollard light / wall light
- * HESTIA solar bollard light
- * ATLAS solar bollard light

11~12

Solar Batten Light

- * APOLLO Solar Car Parking Light

13~14

Solar Flood Light

- * VENUS solar flood light

15~18

Solar Pedestrian Light

- * ATHENA Solar post top light
- * THEMIS Solar Pedestrian Light

19~22

All in Two Solar Street Light

- * HELIOS solar street light (30W ~ 50W)
- * HERMES solar street light (60W ~ 80W)
- * THOR solar street light (100W ~ 120W)

23~28

Vertical Solar Module & Light

- * SolarWrap vertical solar module
- * Vertical solar street light
- * Vertical solar garden light

29~34

All in One Solar Street Light

- * MILIO AIO solar street light
- * ZAIN AIO solar street light

35~36

AC/DC Solar Street Light Head

- * GALAXY solar street light (60W ~ 180W)



KEY FEATURES

The white version and RGBCW version are available, The white version offers the color options as 3000K, 4000K, and 6000K via push button. Any color is accessible with the RGBCW version by the 2.4G magic remote control. It creates a very fantastic night with any color you want.

2.4G Remote Control

2.4G remote performs more greatly than the IR remote. One remote is able to control all the solar lights at the same time within 30 meters in the open air without signal delay. All the lights could be set with the same performance synchronously.

Lithium Battery

The top-quality LifePO4 3.2V 12AH battery is equipped inside with up to 4 days autonomy, the Lifetime time is more than 6000 cycles with D.O.D 80% . It ensures the best stability of the complete system working up for 10 years without maintenance.

Long Lifetime

The solar bollard lights are designed to illuminate the places that require lighting constantly. The rated lifetime is up to 10 years without maintenance. It is an ideal solar light with high cost-effective for domestic use and commercial use.

ARKO Solar Bollard Light

Compared with all the solar bollard lights on the market, there is a dome made of polycarbonate with a high transmittance ratio of 96% to protect the solar panel from the strike, it gets an excellent performance in impact resistance to reach to IK10 level. Thanks to the curved dome over the solar panel, the dust will be flushed away easily in rainy days.

ARKO adopts high efficient 6.2W mono solar panel and brand new LifePO4 battery 3.2V 12AH, it offers a continuous and stable lighting performance with 3~4 nights autonomy. RGBCW full-color changing model with 2.4G remote control is available. It creates fantastic colors for gardens at night.

Model name	ARKO AI-GL260R
Lighting performance	1.5W >220lm
Solar panel	5V 6.2W
Product size	φ260mm 60cm / 90cm / wall mounted
Light color	CCT changeable / RGBCW
LifePO4 battery	3.2V 12AH
Charge & discharge time	5 & >24 hours
Fixture color	Black / Grey
Certificates	CE ROHS CB IP65 IK10
Waranty	3 years



ATOM



ATOM Solar Lawn Light



ATOM is a solar lawn lamp developed with high quality standards. The lamp body adopts a die-cast aluminum shell and a UV-resistant and anti-aging plastic shell. Compared with other products of the same type, ATOM has better appearance design and more uniform lighting effect. This lamp uses long-lasting lithium batteries and high-quality monocrystalline solar panels with a lifespan of more than 25 years. It can work continuously for more than three days on rainy days and has a service life of 8 years.

This product is easy to install . It can be directly surface mounted or installed by ground plug which is very suitable as a “DIY” product. Suitable for sales through professional retail and wholesale channels.

Model name	ATOM ASL07
Lighting performance	1.5W >280lm
Solar panel	5V 6.0W
Product size	φ258 * 300mm
CCT	2700K ~ 6000K
LifePO4 battery	3.2V 12AH
Charge & discharge time	5 & >24 hours
Fixture color	Black / Grey
Certificates	CE ROHS CB IP65 IK10
Waranty	3 years

MUSE

Solar Bollard Light • Solar Wall Light

IK10 Vandal Resistant • No Light Pollution

MUSES is an IK10 vandal-resistant solar bollard light to meet the lighting requirement of Dark Sky which is meant to protect wild animals at night from lighting pollution. It adopts very tough and thick aluminum die casting, the solar panel is covered with a polycarbonate dome to reach the IK10 level of vandal-resistant proof performance.

MUSES is an ideal solar light to bring lighting at night in gardens, backyards, pathways, sidewalks, public parks, etc.





Model name	<i>MUSE AI-GL275R</i>	<i>MUSE AI-GL275R/W</i>
Lighting performance	1.5W 280lm max	●
Solar panel	5V 6.2W	●
Product size	φ275mm Height : 90cm	323*275*195mm
Light color	2300K ~ 6000K	●
LifePO4 battery	3.2V 12AH	●
Charge & discharge time	5 hours & >24 hours	●
Motion sensor	PIR sensor	●
Fixture color	Black / Grey	Wall mounted
IP rate	IP65	●
Certificates	CE ROHS IK10 IP65	●
Warranty	5 years	●



HESTIA





HESTIA

Solar Bollard Light

single or dual light direction outputs

HESTIA is a flexible solar lawn lamp. The original intention of development is to make a lamp meet different design needs at the same time. You can choose symmetrical two-sided light or single-color light according to different lighting environments.

HESTIA is IDA (International-Dark Sky Association) certified without light pollution and it could be animals friendly with CCT 2700K. It is suitable for installation at the beach, villa areas, back gardens, parks and other places. The IK10 explosion-proof solution is adopted, and the solar panels are protected by plastic covers to prevent external hits from stones and sticks.

Model name	HESTIA ASL06
Lighting performance	1.5W >280lm
Solar panel	5V 6.0W
Product size	φ275mm Height : 90cm
CCT	2700K ~ 6000K
LifePO4 battery	3.2V 12AH
Charge & discharge time	5 & >24 hours
Fixture color	Black / Grey
Certificates	CE ROHS CB IP65 IK10
Waranty	3 years

ATLAS



ATLAS Solar Bollard Light

Indestructible • IK10 PRO



ATLAS is a high-quality solar lawn lamp which performs excellent in vandal-resistant and outlook design. It is perfect for lighting in public places. The head of luminaire is made of super weather-resistant plastic material from the indicated brand SABIC, which has superb anti-aging, anti-UV, and non-yellowing properties.

ATLAS can be widely used in many application scenarios like walking paths , villa paths, camping , backyard etc. It has the advantages of simple installation, no maintenance and long service life. Among similar products currently on the market, ATLAS has the best quality in all product tests.

Model name	ATLAS ASL10
Lighting performance	1.5W >280lm
Solar panel	5V 6.2W
Product size	φ275 * 900mm
CCT	2700K ~ 6000K
LifePO4 battery	3.2V 12AH
Charge & discharge time	5 & >24 hours
Fixture color	Black / Grey
Certificates	CE ROHS CB IP65 IK10
Waranty	3 years

APOLLO



APOLLO

Solar Car Parking Light

APOLLO solar car parking light is a good choice for vast solar lighting applications. It is capable of meeting many applications and challenging solar lighting requirements with extremely simple and easy installation capability. It is a perfect solution for many outdoor applications such as carports, bus shelters, warehouses, temporary shelters, camping tents, boats, etc

Lithium batteries and high charging efficiency solar controller are built inside of the light. And it reaches high lumens output of up to 160lm/watt with super bright led chips. It adopts a brand new quality LiFePO4 battery pack whose lifetime is up to 10 years. IP65 weatherproof lighting fixture. The easy MC4 plug-in setup makes the light extremely easy to install and portable. Distance from solar panel to light is up to 20 meters.

A microwave sensor is built inside to save more energy, the lighting mode could be easily programmed as required to meet different application scenes.



Model name	<i>AI-X2200</i>	<i>AI-X4200</i>
LED power	18W max	36W max
Luminous flux(lm)	>2,200lm	>4,200lm
Solar panel	50W 18V	80W 18V
LifePO4 battery	12.8V 154WH	12.8V 307WH
Product size	92*84*600mm	92*84*900mm
Light color	3000K ~ 6000K	●
Charge controller	Programmable PWM	●
Motion sensor	Microwave	●
IP & IK rate	IP65 & IK10	●
Warranty	5 Years	●

VENUS

Solar Flood Light

VENUS solar flood light was developed to satisfy the demand of premium customers who are caring about the quality, not limited to the finishing of lights, but also the aesthetic appearance, battery stability, lighting efficiency, also convenient operation, and motion sensor detection.

VENUS solar-led floodlight adopts the latest technology of control system to balance between the solar panel and lithium battery. The brand new lithium battery is built inside to store the energy to extend the light lifetime up to 10 years. The quality solar panel is able to charge the battery well even during very challenging days no matter on cloudy days or in wintertime, ensuring to provide continuous lighting service without blackout.

Microwave motion sensor function could be turned ON/OFF freely via 2.4G remote control, The popular lighting programs are built-in to allow users to select easily, what's more, the light also can work at day time when the battery is charging by the solar panel. One 2.4G remote control would control all the lights in the same group within 20 meters.

VENUS is the best solar flood light on market!
RGBCW color changing version with remote are also available.





LED Power Adjustable



Motion Sensor Detection



4H 6H 12H settable

Model No.	V2-PRO	V4-PRO	V6-PRO	V8-PRO
Lighting 6000K	4.8W 880lm	9.0W 1,680lm	13.5W 2,480lm	18.5W 3,280lm
Solar panel	12W 10V	25W 10V	35W 10V	50W 10V
LifePO4 battery	6.4V 38.4WH	6.4V 76.8WH	6.4V 115WH	6.4V 154WH
Light size	240*168*56mm	305*235*56mm	375*275*56mm	375*275*56mm
Light color	3000K ~ 6000K or RGBCW	•	•	•
Remote type	2.4G	•	•	•
Motion sensor	Microwave	•	•	•
IP rate	IP65	•	•	•
Warranty	3 Years	•	•	•

A tall, slender, black solar pedestrian light stands on a paved walkway at dusk. The light fixture is a modern, circular design with a warm glow. In the background, other similar lights line the path, which runs alongside a body of water. The sky is a deep blue, and distant mountains are visible on the horizon.

AI HENA

Solar Pedestrian Light | Post Top Light

Athena solar garden light efficiently illuminates your recreational living areas, gardens, and pathways with 360-degree beam, glare-free lighting in solar energy, and stand-alone off-grid functioning. Athena is aesthetically designed for comfortable living but elegant styling suitable for home and hospitality applications with zero operational costs. With the built-in lighting programs, the lighting power and working time could be easily adjusted as required via the remote control.

The light can also work in motion detecting mode which will help to save more energy. Athena is a suitable solar pedestrian light to work perfectly no matter in gulf countries with 5.5 hours of valid sunshine or in north Europe with 2.5 hours of valid sunshine.



Model No.	<i>AI-GL600R</i>
Lighting	18W max 2,800lm
CCT	3000K+4000K or 3000K+6000K
Solar panel	42W 18V MONO
LifePO4 battery	12.8V 154WH
Charge controller	MPPT high efficienct 97%
Dimension	φ600*H455mm
Motion sensor	Microwave
IP rate	IP65
Warranty	5 Years

LED Power Adjustable

Dual CCT Changeable

Motion Sensor Detection

ON - OFF
Dusk to Dawn Auto ON/OFF

4H 6H 12H settable

3000 Cycles LifePO4 Battery



THEMIS

Solar Post Top Light

THEMIS solar pedestrian light is a futuristic design of solar light. It is developed to protect wild animals from blue-light harm of led lighting. With UGR<1% performance. It is able to provide a very well smooth lighting performance at night without any pollution.

It is a combination of high efficient MONO solar panel and LiFePO4 battery and MPPT solar charge controller. It offers ultra brightness output up to 190lm/W with the lowest led power consumption. It is able to bring light to the night continuously and stably even if the sunshine is very weak. The lighting power and period are settable as required to create the best performance. THEMIS is the best solar light to be used for gardens, parks, walk paths, and bicycle lanes. The designed lifetime is up to 10 years without any maintenance.



Model No.	AI-GL590R
Lighting	18W max 2,800lm
CCT	3000K + 4000K 3000K + 6000K
Solar panel	38W 18V MONO
LifePO4 battery	12.8V 154WH
Charge controller	MPPT high efficienct 97%
Dimension	φ590*H550mm
Sensor type	PIR
IP rate	IP65
Warranty	5 Years

4H / 6H / 12H
changeable

LED Power
Adjustable

Dual CCT
Changeable

3000 Cycles
LifePO4 Battery

Motion Sensor
Detection

ON - OFF
Dusk to Dawn
Auto ON/OFF

Integrated

AIT Solar Street Lights

- * Ultra high brightness
 - * Big battery capacity
 - * Constant high power
 - * MC4 connectlon
-

All in Two solar street lights are designed for commercial solar street lighting projects which require constant and high brightness performance. It integrates the brand new lifePO4 battery, MPPT solar charge controller, and the latest technology of led technology. It offers up to 160lm per watt high brightness performance constantly without dimming. It is an ideal choice for commercial solar street lighting which fits different heights of poles up to 12 meters. The solar light head is connected to solar panel by the universal MC4 plugs. Three models are available HELIOS for 20W 30W and 50W, HERMES is for 60W and 80W, and THOR is for 80W,100W, and 120W. All the specifications can be customized according to the client's requests.





HELIOS (30W & 50W)



HERMES (60W & 80W)



THOR (100W & 120W)

LEDiL

LEDil Optics

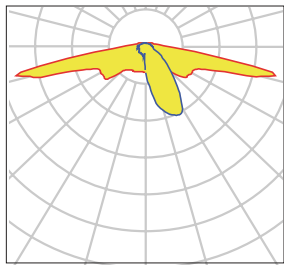

T2-L
IESNA Type II
(long)

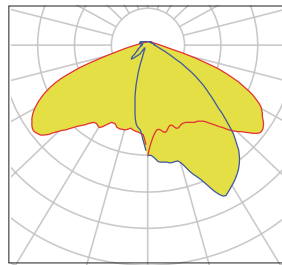

T2-S
IESNA Type II
(short)

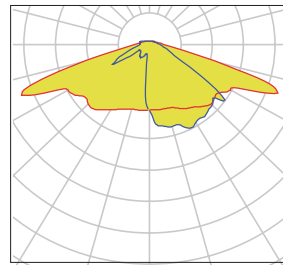

T3
IESNA Type III
(medium)

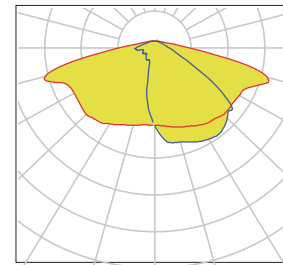

T3B
IESNA Type III
(medium min backlight)

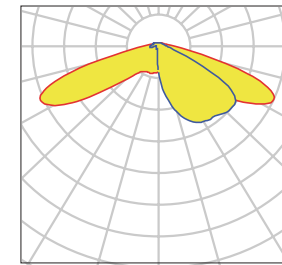

T3-M
IESNA Type III
(medium)

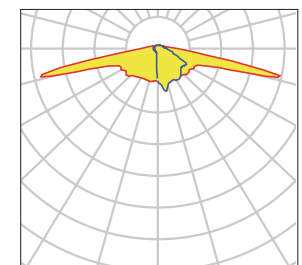

T3-L
IESNA Type III
(long)

Main Specification

Item No.	<i>HELIOS T3</i>	<i>HELIOS T5</i>	<i>HERMES T6</i>	<i>HERMES T8</i>	<i>THOR T10</i>	<i>THOR T12</i>
Rated LED Power	30W	50W	60W	80W	100W	120W
Peak Luminous Flux	5,100lm	8,500lm	10,200lm	13,600lm	16,800lm	20,400lm
CRI	>79	●	●	●	●	●
LED Type	SMD3030 90 pcs	●	SMD5050 64pcs 5W/led		SMD5050 64pcs 5W/led	●
CCT Range	3000K ~ 6000K	●	●	●	●	
Beam Angle	Type I / II / III		●			
Battery Capacity	307WH 12.8V	460WH 12.8V	538WH 12.8V	768WH 25.6V	921WH 25.6V	1075WH 25.6V
Battery Type	Brand new LifePO4 32700 6000mA 3.2V		●	●	●	●
Battery Lifetime	D.O.D 80% 6000 cycles	●	●	●	●	●
Charge Time	4 hours	●	●	●	●	●
Discharge Time	>24 hours	●	●	●	●	●
Advanced System	Solar + 220V + Wind Turbo / Zigbee Wireless Control optional					
Regular Solar Panel	80W 18V	100W 18V	120W 18V	160W 36V	200W 36V	260W 36V
Vertical Solar Module	200W 18V	280W 18V	400W 18V	560W 36V	600W 36V	800W 36V
Cable & Connector	2.5mm ² 0.6 meters with MC4 connectors		●	●	●	●
Working Temp.	-20 °C ~ 75 °C	●	●	●	●	●
Control Method	Automatic ON/OFF dusk to dawn		●	●	●	●
Default Lighting modes	3 hours 100% + 4 hours 50% + 5 Hours 30%		●	●	●	●
Fixture Size	HELIOS : 610*265*98mm		HERMES : 675*277*109mm		THOR : 800*310*116mm	
Painting color	Gray RAL7005	●	●	●	●	
N.W/Light	9.80kg	10.60kg	14.30kg	15.40kg	18.80kg	19.60kg
G.W/Light	10.70kg	11.20kg	15.30kg	16.40kg	20.40kg	21.80kg
IP Rate	IP67	●	●	●	●	●
Warranty	3 years	●	●	●	●	●
Certificates	CB CE ROHS IP67 LM79 LM80 FCC		●	●	●	●

Key Components



LiFePO4 Battery

Ultra-long lifetime and high capacity of LifePO4 battery pack are built inside of light fixture, Lifetime of complete light is more than 10 years without maintenance.



Remote Control

The lighting program can be easily modified according to your requirements, so more energy could be saved and working time will be extended at weak sunshine days. Also the lifetime of the battery are extended.



MPPT Charge Controller

As the "CPU" of solar light, MPPT solar controller from SRNE is adopted for all series of street lights. Increasing the charging efficiency by 30% than PWM, ensuring the more stable performance of the system.



Lumileds LED

It adopts ultra-high brightness of Philips Lumileds led chip. The idea is to use the highest efficiency of led chips to provide the best lighting performance with the minimum led power consumption.



LEDil Optics

More light is falling on the center of the road directly, Reducing the waste of light that is falling out of the road. Different lighting patterns of lenses are available to satisfy different project requirements.



2.5mm² Solar Cable

2.5mm cable reduces the power consumption wasted on components, MC4 connector makes connection easy and durable. Can plug into any solar panel via MC4.



SolarWrap

Vertical Solar Street Light

SolarWrap Integrated Solar Pole Systems from Auroras are our most advanced and innovative solar module for various pole-mounted PV applications. SolarWrap's patented design, manufactured to high-quality standards, can meet decorative and high-end applications, especially for the area and garden lighting without compromising aesthetics. SolarWrap is the outcome of our constant R&D in Solar Lighting, equipped with highly efficient solar modules in a hexagonal aluminum die-cast structure for maximum performance, strength, and durability in many challenging applications. The innovation can be integrated into any pole shape and dimensions, making the SolarWrap Integrated Solar Pole almost universal. The detachable and lightweight design helps in easy installation for a complete maintenance-free life.

The complete solar pole only includes two functional components including vertical solar modules and solar light heads which can be connected to each other directly by MC4 connectors. The battery and solar controller are built inside of the light fixture. The powers of solar light heads are from 20W to 120W to meet most requirements of projects. The vertical solar-led street light pole is a premium and advanced product. It is designed especially for these projects concerning a lot on aesthetical appearance with high luminous flux, durable quality system, and long time use without any maintenance.

It could be widely used for outdoor monitors, traffic lights, signal centers etc. It is also an ideal solution to retrofit the traditional street lights whose lighting bulbs are metal-halide. It only needs to attach the SolarWrap vertical solar module to existing poles without setting new poles. This provides a brand new possibility to save energy by solar power for traditional street lights with minimum cost.



360° Full Day Charging

6 slim solar panels are fixed tightly on a hexagon frame, so it ensures 50% of solar panel will face to sunshine at any time of the day.



Modular Installation

This vertical solar module is based on modular design concept for easy installation and disassembly. It can be quickly and easily mounted on any suitable pole within max diameter 155mm.



Strong Wind Resistance

The vertical design reduces the wind resistance area, and each module is directly fastened to the pole by 12 screws for better wind resistance. It can stand well against 24.5m/s typhoon.



Never Snow Covering

Solar cylinder modular mounted in vertical, it is not easy to be covered by snow as regular solar panel. Ensure enough power can be generated even in very snowy climate. Never worry black out.



Easy to Clean

Less dust will fall on surface than regular solar panel. Worker can clean it easily standing on ground with a long handle brush, no need lift. higher work efficiency and less maintenance cost.

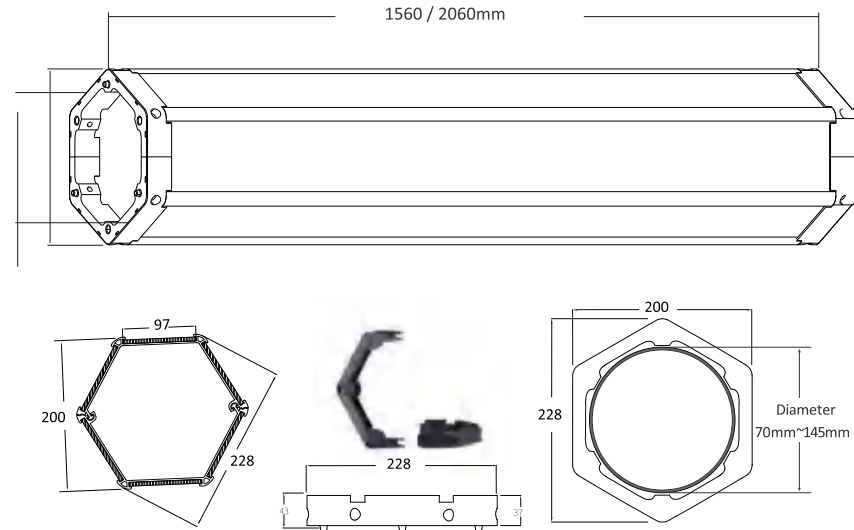

Item number	Q140	Q200
Dimension	228*200*1560mm	228*200*2060mm
Pmax	140W	200W
Vmp & Imp	18V 7.78A 36V 3.88A	18V 11.1A 36V 5.56A
Cell type	MONO made in Taiwan	•
Solar cell efficiency	22.70%	•
Cable & Connector	Universal MC4 with 0.6 meter 2.5mm ²	•
Structure material	UPVC + aluminum alloy / aluminum alloy	•
Operating temp.	-20 C ~ +70 C	•
PV Lifetime	>20 years	•
N.W / G.W	19.80kg / 21.70kg	25.50kg / 27.80kg
Max pole diameter	145mm	•
Warranty	5 years	•

Recommended Pole Configuration

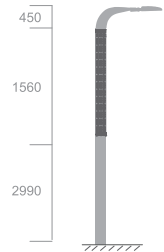

30W

Order code	S03020005
Solar light head	HELIOS 30W
LED power	30W
Luminous flux(lm)	5,100lm
Power of solar module	200W
Vertical solar module	Q200 1pc
LifePO4 battery	12.8V 307WH
Charge controller	MPPT
Pole height	5 meters
Warranty	3 years

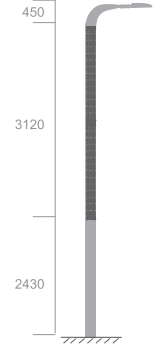

50W

Order code	D03040006
Solar light head	HELIOS U50W
LED power	50W
Luminous flux(lm)	7,500lm
Power of solar module	280W
Vertical solar module	Q140 2pcs
LifePO4 battery	12.8V 460WH
Charge controller	MPPT
Pole height	6 meters
Warranty	3 years

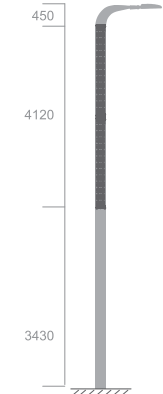

60W

Order code	S06040008
Solar light head	HERMES T6
LED power	60W
Luminous flux(lm)	10,200lm
Power of solar module	400W
Vertical solar module	Q200 2pcs
LifePO4 battery	12.8V 538WH
Charge controller	MPPT
Pole height	8 meters
Warranty	3 years

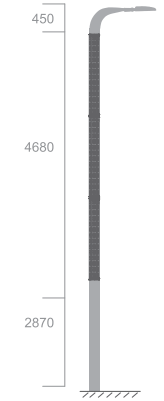

80W

Order code	S08042008
Solar light head	HERMES T8
LED power	80W
Luminous flux(lm)	13,600lm
Power of solar module	420W
Vertical solar module	Q140 3pcs
LifePO4 battery	25.6V 768WH
Charge controller	MPPT
Pole height	8 meters
Warranty	3 years

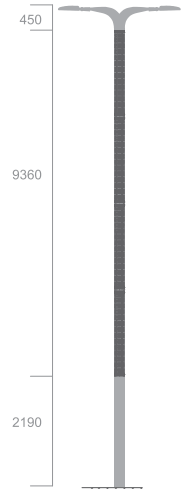

60W*2

Order code	D06080012
Solar light head	HERMES T6
LED power	60W * 2
Luminous flux(lm)	10,200lm * 2
Power of solar module	800W
Vertical solar module	Q200 4pcs
LifePO4 battery	25.6V 768WH * 2
Charge controller	MPPT
Pole height	12 meters
Warranty	3 years



100W

Order code	S10060012
Solar light head	THOR T10
LED power	100W
Luminous flux(lm)	17,000lm
Power of solar module	600W
Vertical solar module	Q200 3pcs
LifePO4 battery	25.6V 1075WH
Charge controller	MPPT
Pole height	12 meters
Warranty	3 years



Vertical Solar Garden Light | Pole Light

The vertical solar pole light is designed to meet the demand of the premium projects which require aesthetic appearance as well as high-quality lighting performance.

The vertical solar pole is composed of 4 components: garden light head, LiFePO4 battery pack with the MPPT controller built-in, steel pole, and solawrap vertical solar module. Compared with the solar led garden lights with regular solar panel, vertical ones are more attractive with compact structures. Brand new LiFePO4 battery is adopted to store energy whose lifetime is 4000 cycles at D.O.D 50%.The designed lifetime of the system is more than 10 years without any maintenance. The high efficiency 97% MPPT solar charge controller is adopted to ensure sufficient power be generated to satisfy the led light consumption. The vertical solar pole is very flexible for your marketing and projects. The steel pole could be easily customized according to projects' requirements and arranged locally in order to save shipping costs. And any model of the light head could be adoptable freely.





ZEUS Solar Garden Light

Item name	ZEUS
LED Power (max)	30W
Luminous flux(lm)	4,400lm
CCT	3000K~6000k
Pole height	2.5 ~ 3.5 meters
Vertical PV	200W 18V
LiFePO4 Battery	12.8V 307WH
Battery location	Inside of pole
Solar Controller	Programmable MPPT
System lifetime	> 10 Years
Waranty	5 years



ARTEMIS Solar Garden Light

Item name	ARTEMIS	ARTEMIS-Pro
LED Power (max)	30W	60W
Luminous flux(lm)	4,400lm	8,800lm
CCT	3000K~6000k	3000K~6000k
Pole height	3 ~ 4 meters	4 ~ 6 meters
Vertical solar module	200W 18V	280W 18V
LiFePO4 Battery	12.8V 307WH	12.8V 615WH
Battery location	Inside of pole	•
Solar Controller	Programmable MPPT	•
System lifetime	> 10 Years	•
Waranty	5 years	•



MILIO AIO Solar Street Light

MILIO is a compact solar light that can provide all-around lighting, suitable for poles of 4 meters to 6 meters, and various installation environments like car parking areas, pedestrian paths, etc. It can be mounted on a straight bar or plugged into the arm of the pole. The led engine is designed with an inclined angle to improve the utilization of light. It has a built-in MPPT solar controller with a charging efficiency of up to 97% and a brand-new top-quality A-grade lithium iron phosphate battery. The motion sensor is also equipped.

You can use the remote control to set different working modes to meet various lighting needs whether it is winter or summer, it can provide stable lighting services 365 days a year.

Main Specification

Item number	<i>AIO-30WM</i>	<i>AIO-50WM</i>
Peak luminous flux	30W 5,100lm	50W 8,500lm
CCT	2700K~6000K	2700K~6000K
LED chips	24pcs SMD5050	24pcs SMD5050
LiFePO4 battery	230WH 12.8V	384WH 12.8V
Solar panel	60W 18V	60W 18V
Solar charge controller	MPPT with PIR remote	MPPT with PIR remote
Product size	900*380*88mm	900*380*88mm
Plug-in Installation	60mm	60mm
Straight pole installation	60mm~80mm	60mm~80mm
Warranty	3 years	3 years



The lamp body is designed with a 15-degree inclination angle, making the light more uniform and higher utilization rate



The battery and controller are easily accessed for future possible maintenance by unfixing the screws of the battery cover.



Committed to 3 years warranty for complete light including battery and controller. Using top quality of all componenty.



Built-in a variety of lighting programs, you can use the remote control to easily change the settings to meet different lighting conditions





ZAIN AIO Solar Street Light

ZAIN is the perfect solar lighting for the outdoors, it caters requirements of all applications, ZAIN has wide power ranges from 50W to 180W which apply pole heights from 5 meters to 14 meters. It is the latest compact solar street light, integrating the most cutting-edge technology of lithium battery and highest led technology as well as with highly efficient PV module and charge control technology. Always there is one suitable model for your project.



The use of 5050 lamp beads improves the luminous efficiency of the lamp beads, which can reach 170lm per watt.



Adopt MPPT solar controller with efficiency up to 97% to improve charging efficiency.



Different lighting programs are built inside and can be chosen by remote control easily. Summer mode and winter mode are available for more days of battery backup.



Smart wireless Zigbee control scheme is available, using European standard ZHAGA connector.



The led module is rotatable, lighting angle is adjustable to make more light to fall on the road without wasting light.



Adopting modular structure design, the battery box and solar panel are easy to disassemble

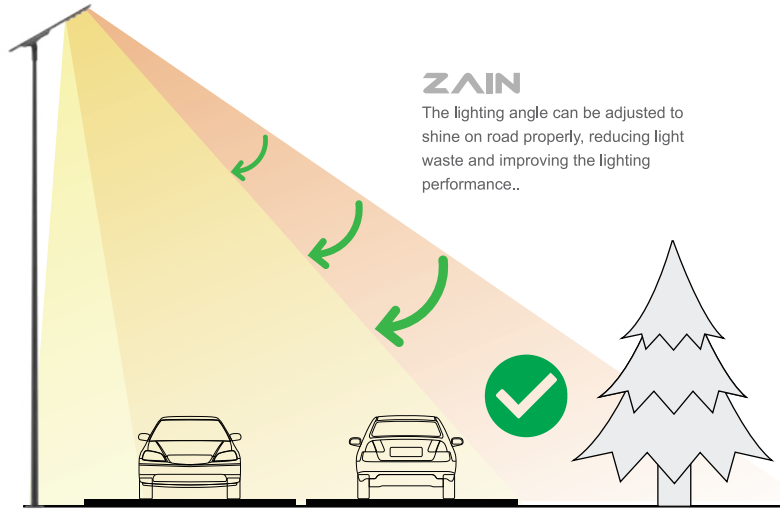

Performance of ZAIN AIO Solar Street Lights

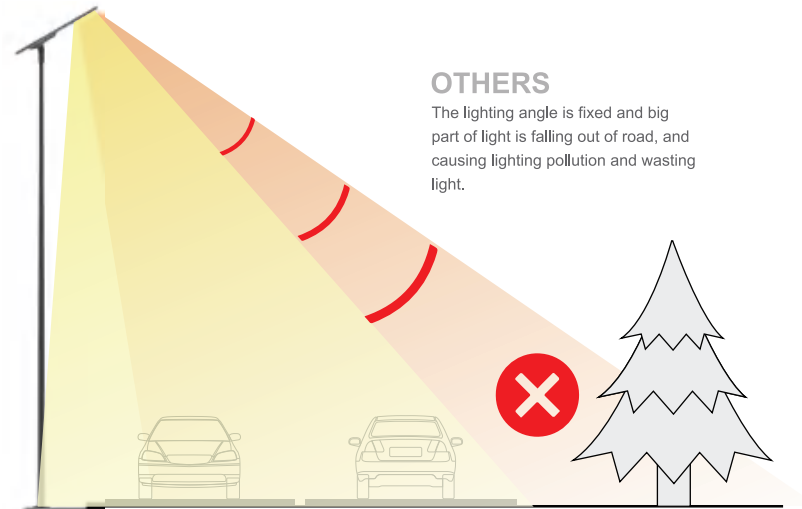

Performance of Other AIO Solar Street Lights

VS

The rotatable led module

Due to the high integration of the integrated street light, it is easy to install and greatly reduces the installation cost and other costs. However, since the angle of the sun is different in each country or region, ordinary all-in-one solar street lights cannot adjust the angle according to the position of the sun. The light of the lamp can only be irradiated to places other than the road surface, which causes a waste of light and may cause light pollution. Or in order to allow the light to shine on the road as much as possible, but it is impossible to make the solar panel the most suitable angle for facing the sun.

ZAIN series solar street lights perfectly solve the problems mentioned above. ZAIN adopts high-strength, angle-adjustable, and beautiful die-casting aluminum brackets, and at the same time allows the LED light source module to have the function of adjusting the angle. Each LED module has a The angle can be adjusted manually, with self-locking function, without wrench adjustment, so that the light can be properly irradiated on the road, which greatly improves the efficiency of light use, and can also make the solar panel face the sun to maximize the power generation efficiency.

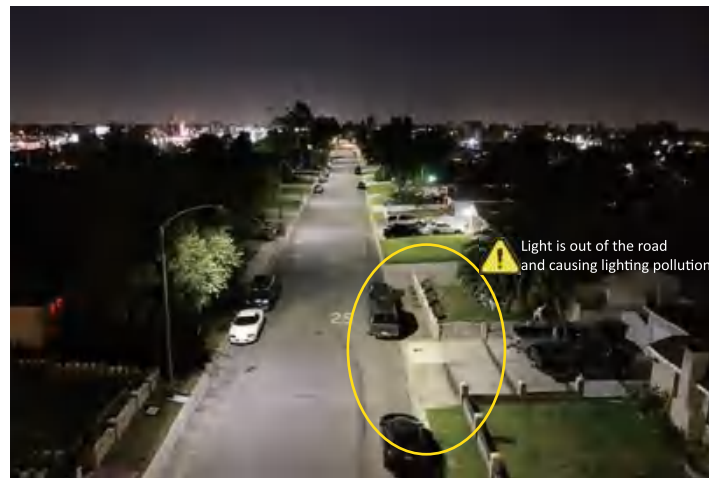

Main Specification

Item number	<i>AIO-50WZ</i>	<i>AIO-60WZ</i>	<i>AIO-80WZ</i>	<i>AIO-100WZ</i>
LED power & luminous	50W 8,500lm	60W 10,200lm	80W 13,600lm	100W 17,000lm
CCT range	2700K~6000K	●	●	●
LED module	2 modules	2 modules	3 modules	4 modules
LiFePO4 battery	12.8V 384WH	12.8V 460WH	12.8V 614WH	12.8V 768WH
Solar panel	18V 64W	18V 82W	18V 103W	18V 125W
Product size	910*420*350mm	1100*420*350mm	1300*420*350mm	1590*420*350mm
Solar charge controller	MPPT with sensor	●	●	●
Pole size	76mm	●	●	●
Installation height	4 ~ 8m	5 ~ 8m	6 ~ 10m	6 ~ 12m
Certificates	CE ROHS CB IP65	●	●	●
Warranty	5 years	●	●	●

Item number	<i>AIO-120WZ</i>	<i>AIO-140WZ</i>
LED power & luminous	120W 20,400lm	140W 23,800lm
CCT range	2700K~6000K	●
LED module	4 modules	5 modules
LiFePO4 battery	25.6V 921WH	25.6V 1075WH (max battery capacity 25.6V 1536WH)
Solar panel	36V 135W	36V 158W
Product size	1360*530*380mm	1480*530*380mm
Solar charge controller	MPPT with sensor	●
Pole size	76mm	●
Installation height	8 ~ 12m	8 ~ 14m
Certificates	CE ROHS CB IP65	●
Warranty	5 years	●



Remark : CCT of 3000 K or lower is required for IDA certification compliance.

When installing, the led module should be in the downward position and facing to ground, and solar panel is facing upward to the sun.

Rotatable Bracket



Application





GALAXY AC/DC Solar Garden Light

Galaxy is a high-power, long-life solar street light, which is specially developed to meet high-standard projects. It can achieve 100% full power output for 12 hours, and has more than 3 days of power backup. The configuration of the system can be flexibly adjusted according to the needs of the project.

The Galaxy street light adopts a modular design, which can reach a high brightness output of 170lm/W, and the battery uses a new lithium iron phosphate battery with a life span of 2000 cycles. The controller adopts the MPPT charging mode, and the working mode and parameters can be conveniently set by the remote control.



solar panel



charge controller



lithium battery / gel battery



Main Specification

Item number	<i>T60-X</i>	<i>T90-X</i>	<i>T120-X</i>	<i>T150-X</i>	<i>T180-X</i>
LED power	60W	90W	120W	150W	180W
luminous flux	10,200lm	15,300lm	20,400lm	25,500lm	29,000lm
CCT range	2700K~6000K	•	•	•	•
LED module	2 modules	3 modules	4modules	5modules	6 modules
System voltage	12V	24V	•	•	•
LiFePO4 battery	12.8V 100AH	25.6V 60AH	25.6V 100AH	25.6V 120AH	25.6V 150AH
Lead acid battery	12V 200AH	24V 150AH	24V 180AH	24V 200AH	24V 230AH
Solar panel	200W 36V Poly	260W 36V Poly	300W 36V Poly	360W 36V Poly	450W 36V Poly
Solar charge controller	Programable MPPT	•	•	•	•
Pole height	6~10 meters	8~12 meters	8~14 meters	10~14 meters	10~14 meters
Certificates	CE ROHS CB	•	•	•	•
Warranty	5 years	•	•	•	•

Remark :

1. The led power is adjustable freely by remote control.
2. There is lead acid battery and LiFePO4 battery are optional.
3. More types of street light heads are available





